



Y.LIN ELECTRONICS CO.,LTD.

## Data Sheet

---

Customer: \_\_\_\_\_  
Part No: YL4201BSWWB6.7(黑面萤光胶)  
Sample No: \_\_\_\_\_  
Description: 0.40" White Total Positive Digital LED  
Item No: \_\_\_\_\_

Customer			
Check	Inspection	Approval	Date

Y.LIN			
Drawn	Check	Approval	Date
			2017/5/12

Mainland address:Jinhe The Third IndustrialZone,Zhangmutou Town,Dongguan,Guangdong,China

H.K address:Unit 503 5/F,Silvercord Tower 230 Canton Road Tsimshatsui

TEL:0769-87181888 FAX:0769-87187333 E-mail:ylin30@y-lin.com [Http://www.yong-lin.net](http://www.yong-lin.net)

---



**Features:**

- . Industrial standard size.
- . Low power consumption.
- . Categorized for luminous intensity.
- . Pb free

**Descriptions :**

- . These displays provide excellent reliability in bright ambient light.
- . These devices are made with white segments and black surface.

**Applications**

- DVD player
- Audio equipment
- Instrument panels
- Digital read out display

**Package Dimensions:**

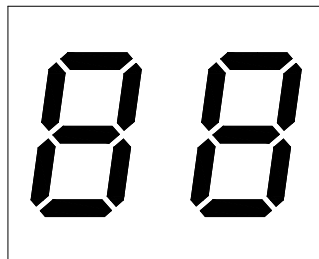
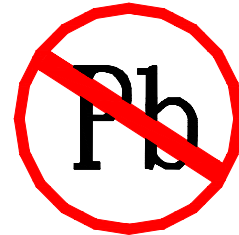



Package Dimensions

YL4201BSWWB6.7

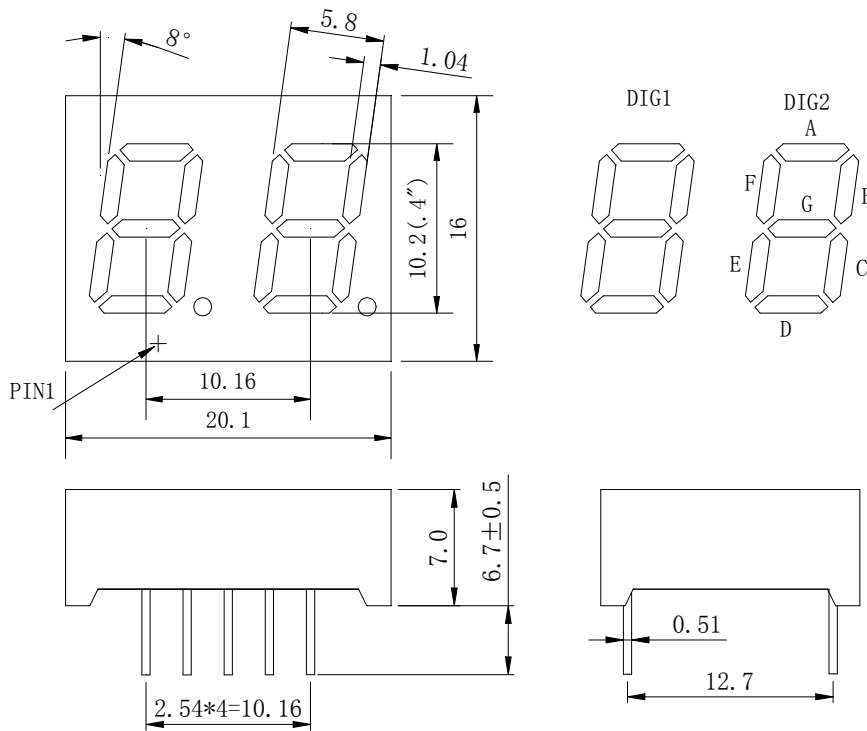

CODE A

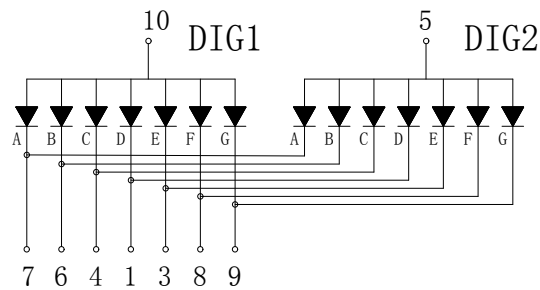

NOTES

- 1.All dimensions are in millimeters .
- 2.Tolerance is ±0.25mm unless otherwise noted.



## YL4201BSWWB6.7

### Selection Guide

Part No.	Dice	Lens Type	Luminous intensity(mcd)			test conditions
			Min	Typ	Max	IF=20mA
YL4201BSWWB6.7	White (InGaN)	White Diffused	200	--	--	

Note:

- 1.1/2 is the angle from optical centerline where the luminous intensity is 1/2 the optical centerline value.
- 2.the above luminous intensity measurement allowance tolerance  $\pm 15\%$

### Electrical / Optical Characteristics at Ta=25°C

Parameter	Symbol	Min.	Typ.	Max	Units	test conditions
Forward Voltage	VF	2.7	3.1	3.6	V	IF=20mA
Reverse Current	IR	--	--	50	uA	VR = 5V
Suggestion Forward Current	IF	1	2-5	15	mA	
Chromaticity Coordinates	x/y	0.24/0.24	0.28/0.28	0.32/0.33		IF=20mA

### Absolute Maximum Ratings at Ta=25°C

Parameter	Symbol	Rating	Units
Power Dissipation	Pd	50	mW
DC Forward Current	IF	20	mA
Peak Forward Current [Duty 1/10 @ 1KHZ]	IFP	60	mA
Reverse Voltage	VR	5	V
Operating Temperature	Topr	-20~+85	°C
Storage Temperature	Tstg	-20~+80	°C
Lead Soldering Temperature [1.6mm(.063") From Body]		260°C for 3 seconds	

Note:

1. 1/10 Dut cycle,0.1ms pulse width.
2. The above forward voltage measure ment allowance tolerance  $\pm 0.1V$ .



### Typical optical characteristics curves

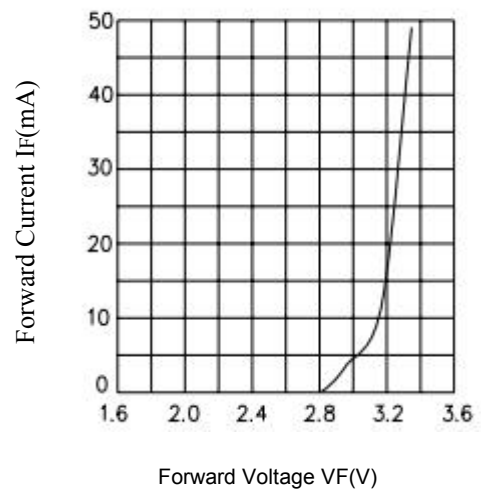
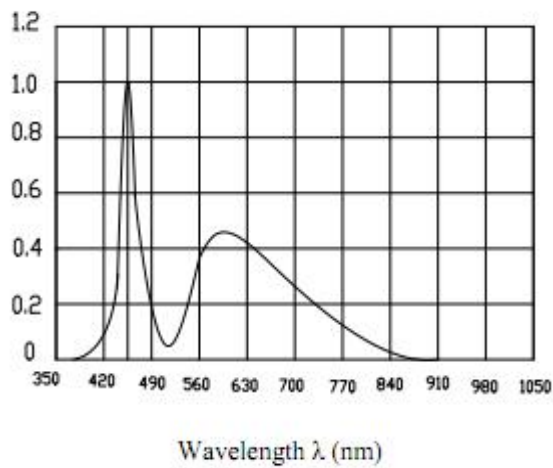
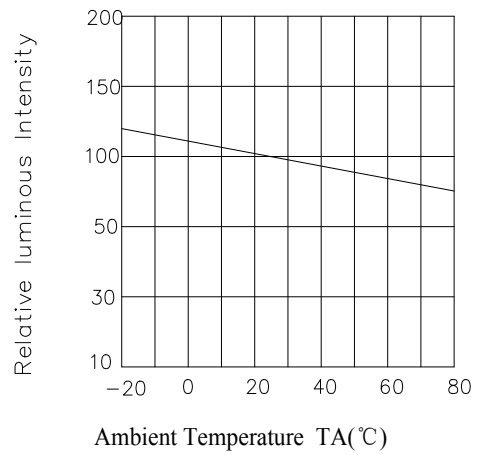
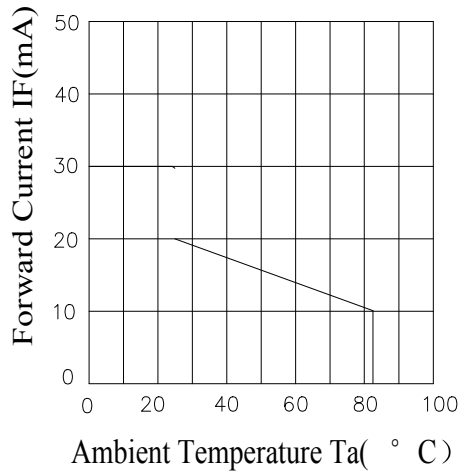



### Reliability Test

NO	Item	Test Conditions	Test Hours/Cycle	Sample Size	Ac/Re
1	Solder Heat	TEMP : 260°C ± 5 °C	5 SEC	76 PCS	0/1
2	Temperature Cycle	H : +85°C 30min ∫ 5 min L : -55°C 30min	50 CYCLE	76 PCS	0/1
3	Thermal Shock	H : +100°C 5min ∫ 10 sec L : -10°C 5min	50 CYCLE	76 PCS	0/1
4	High Temperature Storage	TEMP : 100°C	1000 HRS	76 PCS	0/1
5	Low Temperature Storage	TEMP : -55°C	1000 HRS	76 PCS	0/1
6	DC Operating Life	IF = 10 mA	1000 HRS	76 PCS	0/1
7	High Temperature / High Humidity	85°C/85% RH	1000 HRS	76 PCS	0/1

The appearance and specifications of the product may be modified for improvement,without prior notice.