



Y.LIN ELECTRONICS CO.,LTD.

Data Sheet

Customer: _____
Part No: _____ M3AW4CO _____
Sample No: _____
Description: _____ 3mm Round Infrared _____
Item No: _____

Customer			
Check	Inspection	Approval	Date

Y.LIN			
Drawn	Check	Approval	Date
			2017/5/22

Mainland address: Jinhe The Third Industrial Zone, Zhangmutou Town, Dongguan, Guangdong, China

H.K address: Unit 503 5/F, Silvercord Tower 230 Canton Road Tsimshatsui

TEL: 0769-87181888 FAX: 0769-87187333 E-mail: ylin20@y-lin.com [Http://www.yong-lin.net](http://www.yong-lin.net)



Y. LIN ELECTRONICS CO., LTD.

M3AW4CO

Features:

- . Mechanically and spectrally matched to the phototransistor.
- . Rohs compliant.

Description

- . This devices are made with PIN GaAs.



Package Dimensions:

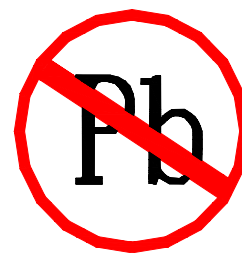
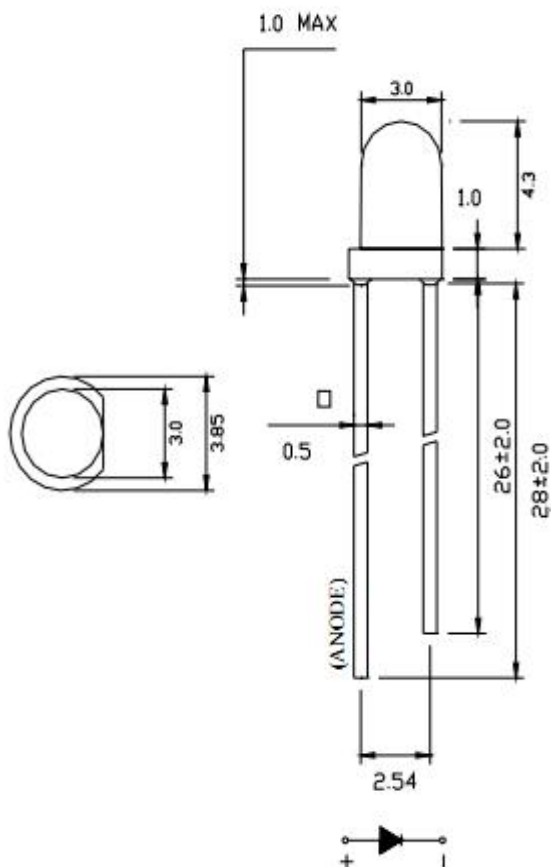

NOTES

- 1.All dimensions are in millimeters .
- 2.Tolerance is $\pm 0.25\text{mm}$ unless otherwise noted.

Lens		Material			Emitting Color	
Water Clear		GaAlAs			Infrared	
Parameter	Symbol	Min.	Typ.	Max	Unit	Test Condition
Radiant Intensity	Ee	3	6		mW/sr	IF=20mA
		15	30			IFP=100mA TP=10us
Controlled Angle	201/2		20		deg	



M3AW4CO

Electrical / Optical Characteristics at Ta=25°C

Parameter	Symbol	Min.	Typ.	Max	Units	test conditions
Peak Wavelength	λ_p		940		nm	
Forward Voltage	V _F	1.0	1.4	1.8	V	I _F =100mA
Reverse Current	I _R			100	μ A	V _R =5V
Switch time	t _r /t _f		15/15		us	V _{CE} =5v I _C =1mA
Spectral bandwidth at 50%			50		nm	I _F =20mA

Note:

- 1.1/2 is the angle from optical centerline where the luminous intensity is 1/2 the optical centerline value.
- 2.the above luminous intensity measurement allowance tolerance $\pm 15\%$

Absolute Maximum Ratings at Ta=25°C

Parameter	Symbol	Rating	Units
Peak Forward Current	I _{FP}	1000	mA
Continuous Forward Current	I _F	20	mA
Reverse Voltage	V _R	5	V
Power Dissipation	P _D	100	mW
Operating Temperature	T _{opr}	-20~+70	°C
Storage Temperature	T _{stg}	-40~+80	°C
Lead Soldering Temperature [1.6mm(.063") From Body]		260°C for 5 seconds	

Note:

1. 1/10 Dut cycle,0.1ms pulse width.
2. The above forward voltage measure ment allowance tolerance $\pm 0.1V$.



M3AW4CO

Typical optical characteristics curves

Fig.1 Forward Current vs. Ambient Temperature

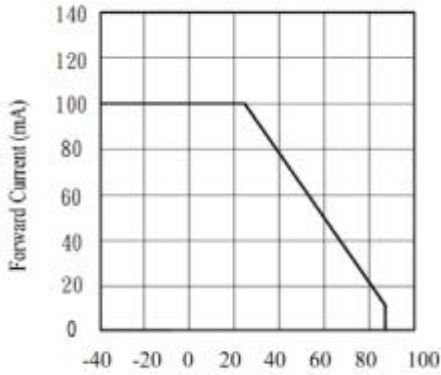

Fig.2 Spectral Distribution

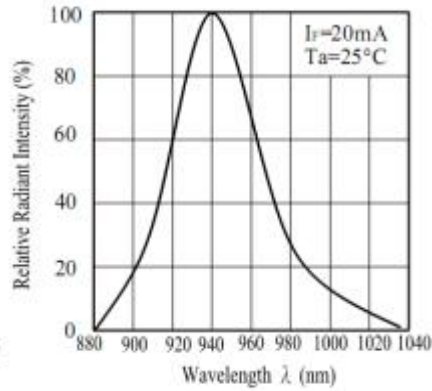

Fig.3 Peak Emission Wavelength vs. Ambient Temperature

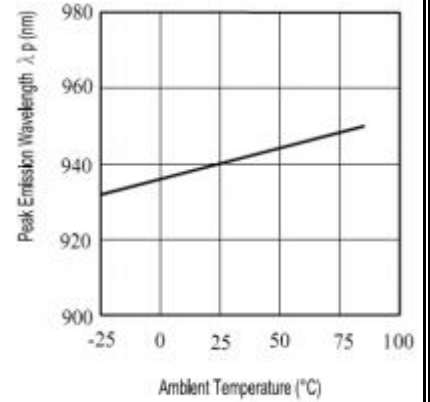

Fig.4 Forward Current vs. Forward Voltage

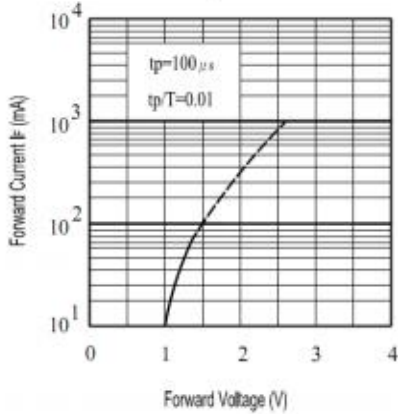

Fig.5 Relative Intensity vs. Forward Current

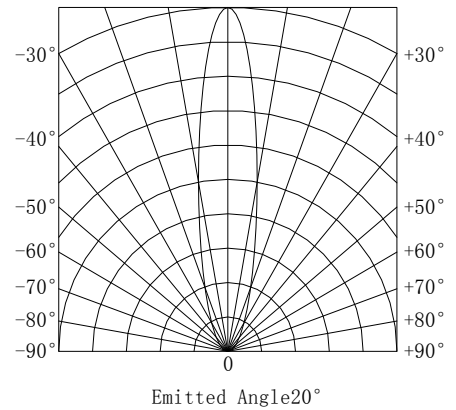
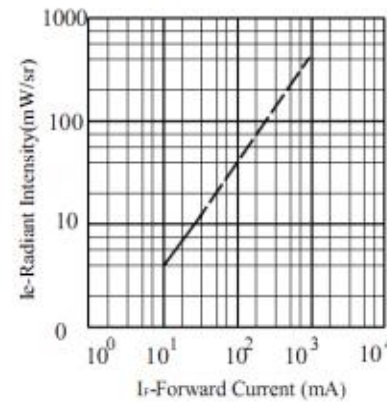

Fig.7 Relative Intensity vs. Ambient Temperature (°C)

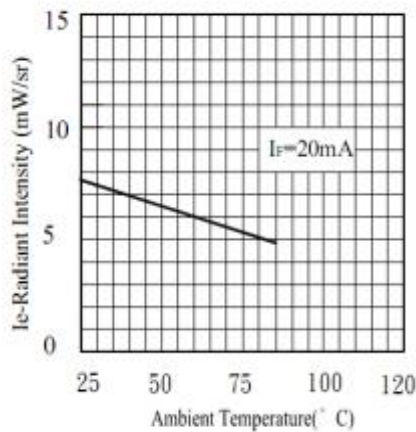
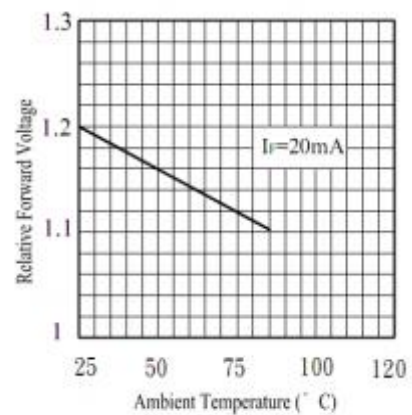

Fig.8 Forward Voltage vs. Ambient Temperature (°C)





M3AW4CO

Reliability Test

Classification	Test Item	Test Condition	Sample	AC/Re
Endurance Test	Operation Life	Ta=Under Room Temperature As Per Data Sheet Maximum Rating *Test Time=1000HRS(-24HRS,+72HRS)	22	0/1
	High Temperature High Humidity Storage	Ta=85°C RH=85% Test Time=1000HRS± 2HRS	22	0/1
	High Temperature High Humidity Reverse BIAS	Ta=85°C RH=85% Test Time=500HRS(-24HRS,+48HRS)	22	0/1
	High Temperature Storage	Ta=105±5°C *Test Time=1000HRS(-24HRS,+72HRS)	22	0/1
	Low Temperature Storage	Ta=-40±5°C *Test Time=1000HRS(-24HRS,+72HRS)	22	0/1
	Environmental Test	Temperature Cycling	105°C ~ 25°C ~ -40°C ~ 25°C 30mins 5mins 30mins 5mins 10Cycles	22
Thermal Shock		105°C±5°C ~ -40°C±5°C 10mins 10mins 10Cycles	22	0/1
Solder Resistance		T.sol=260±5°C Dwell Time=10±1secs	22	0/1
Solderability		T.sol=230±5°C Dwell Time=5±1secs	22	0/1

The appearance and specifications of the product may be modified for improvement, without prior notice.



M3AW4CO

1.Storage

It is recommended that LEDs out of their original packaging are used within three months.

For extended storage out of their original packaging, it is recommended that the LEDs be stored in a sealed container with appropriate desiccant or in desiccators with nitrogen ambient.

2. Cleaning

Use alcohol-based cleaning solvent such as isopropyl alcohol to clean the LEDs if necessary.

3.Soldering

When soldering leave a minimum of 2mm clearance from the base of the lens to the soldering point.

Dipping the lens into the solder must be avoided.

Do not apply any external stress to the lead frame during soldering while the LED is at high temperature.

Recommended soldering conditions:

Soldering iron		Wave soldering	
Temperature	320°C Max	Pre-heat Pre-heat time	100°C Max 60 sec.Max
Soldering time	3 sec.Max (one time only)	Solder wave Soldering time	260°C Max 5 sec.Max

Note: Excessive soldering temperature and/or time might result in deformation of the LED lens or catastrophic failure of the LED.

4.Drive Method

An LED is a current-operated device, In order to ensure intensity uniformity on multiple LEDs connected in parallel in an application, it is recommended that a current limiting resistor be incorporated in the drive circuit, in series with each LED as shown in Circuit A below.

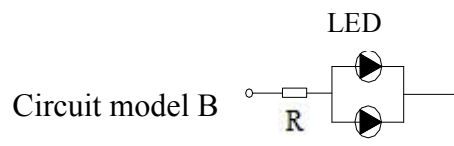
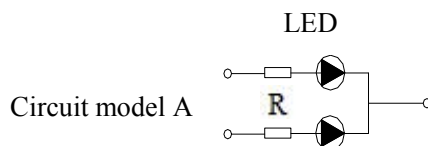

(A) Recommended circuit

(B) The brightness of each LED might appear different due to the differences in the I-V characteristics of those LEDs.