



## Data Sheet

---

Customer: \_\_\_\_\_  
Part No: \_\_\_\_\_ M3AW4C06 \_\_\_\_\_  
Sample No: \_\_\_\_\_  
Description: \_\_\_\_\_ 3mm Round Infrared \_\_\_\_\_  
Item No: \_\_\_\_\_

Customer			
Check	Inspection	Approval	Date

Y.LIN			
Drawn	Check	Approval	Date
			2016-1-8

Mainland address:Jinhe The Third IndustrialZone,Zhangmutou Town,Dongguan,Guangdong,China

H.K address:Unit 503 5/F,Silvercord Tower 230 Canton Road TsimshatsuiKl

TEL:0769-87181888 FAX:0769-87187333 E-mail:ylin28@y-lin.com Http://www.yong-lin.net

---



**M3AW4C06**

**Features:**

- . Mechanically and spectrally matched to the phototransistor.
- . Rohs compliant.

**Description**

- . This devices are made with PIN GaAs.



**Package Dimensions:**

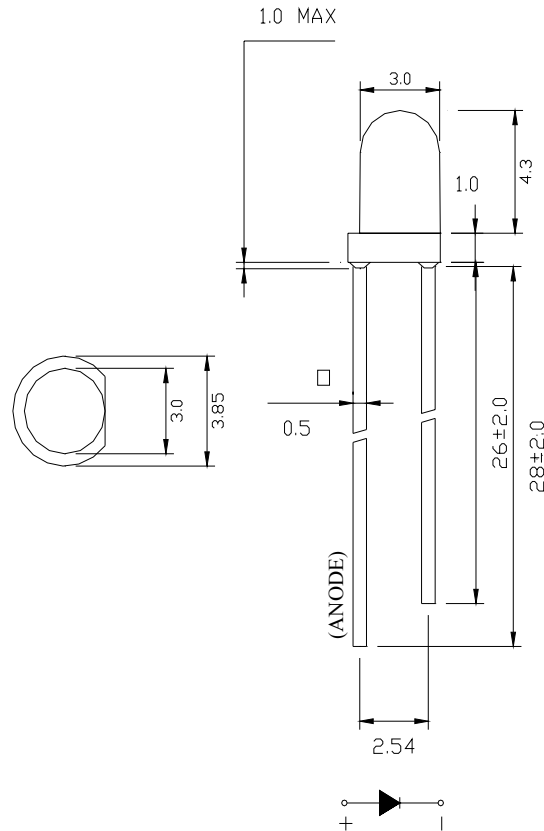

**NOTES**

- 1.All dimensions are in millimeters .
- 2.Tolerance is ±0.25mm unless otherwise noted.

Lens		Material			Emitting Color	
Water Clear		GaAlAs			Infrared	
Parameter	Symbol	Min.	Typ.	Max	Unit	Test Condition
Radiant Intensity	Ee	10	20		mW/sr	IF=20mA
		50	100			IFP=100mA TP=10us
Controlled Angle	2θ1/2		30		deg	



## M3AW4C06

### Electrical / Optical Characteristics at Ta=25°C

Parameter	Symbol	Min.	Typ.	Max	Units	test conditions
Peak Wavelength	$\lambda_p$		850		nm	
Forward Voltage	VF		1.2	1.4	V	IF=20mA
			1.5	1.8		IF=100mA
Reverse Current	IR			10	$\mu$ A	VR=5V
Switch time	tr/tf		15/15		us	VCE=5v IC=1mA
Spectral bandwidth at 50%			50		nm	IF=20mA

Note:

- 1.1/2 is the angle from optical centerline where the luminous intensity is 1/2 the optical centerline value.
- 2.the above luminous intensity measurement allowance tolerance  $\pm 15\%$

### Absolute Maximum Ratings at Ta=25°C

Parameter	Symbol	Rating	Units
Peak Forward Current	IFP	1000	mA
Continuous Forward Current	IF	100	mA
Reverse Voltage	VR	6	V
Power Dissipation	PD	100	mW
Operating Temperature	Topr	-20~+70	°C
Storage Temperature	Tstg	-40~+80	°C
Lead Soldering Temperature [1.6mm(.063") From Body]		260°C for 5 seconds	

Note:

1. 1/10 Dut cycle,0.1ms pulse width.
2. The above forward voltage measure ment allowance tolerance  $\pm 0.1V$ .



## M3AW4C06

### Typical optical characteristics curves

Fig.1 Forward Current vs. Ambient Temperature

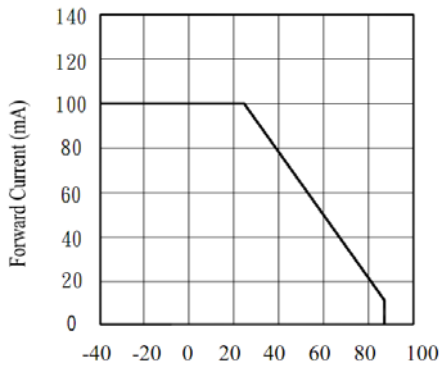

Fig.2 Spectral Distribution

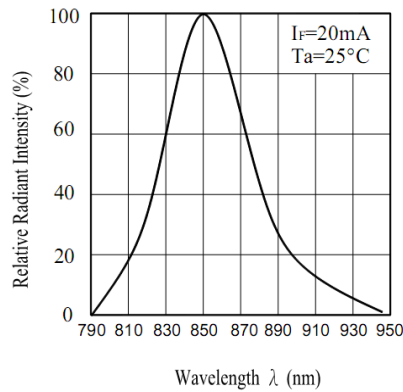

Fig.3 Peak Emission Wavelength vs. Ambient Temperature

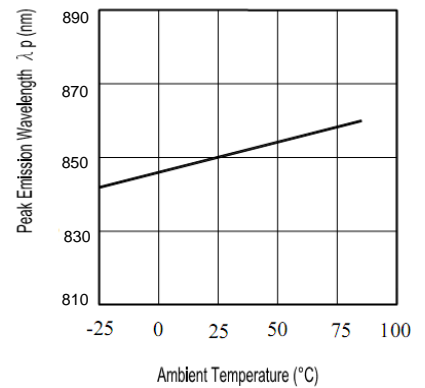

Fig.4 Forward Current vs. Forward Voltage

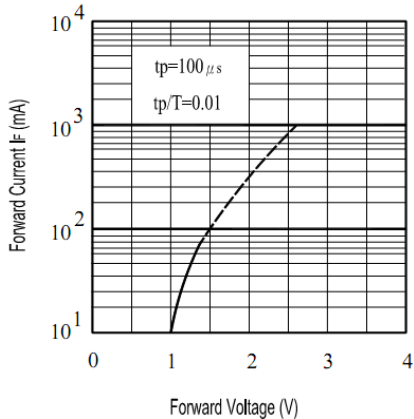

Fig.5 Relative Intensity vs. Forward Current

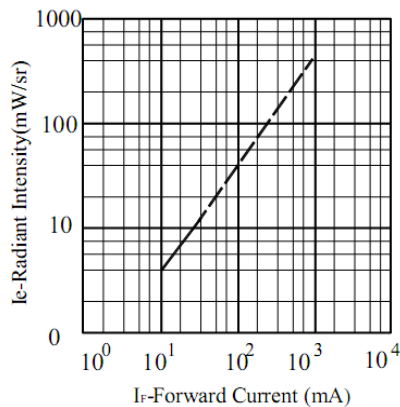

Fig.6 Relative Radiant Intensity vs. Angular Displacement

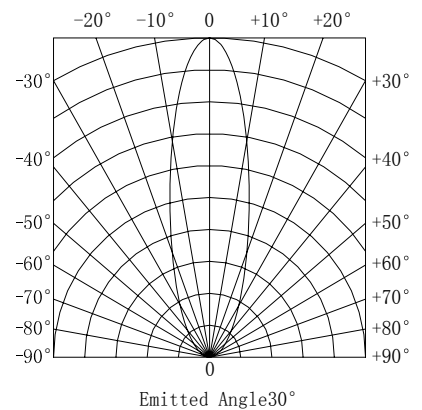

Fig.7 Relative Intensity vs. Ambient Temperature(°C)

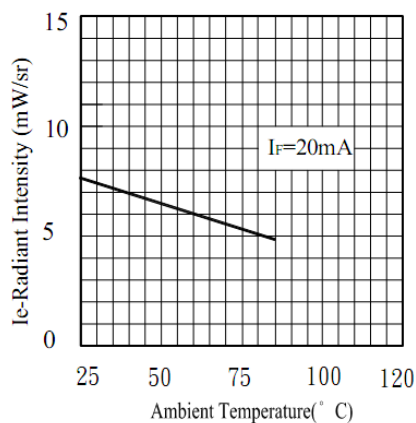
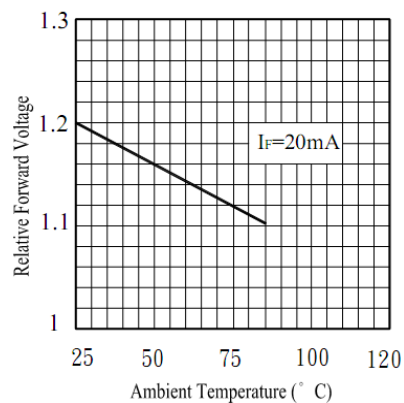

Fig.8 Forward Voltage vs. Ambient Temperature(°C)





## M3AW4C06

### Reliability Test

Classification	Test Item	Test Condition	Sample	AC/Re
Endurance Test	Operation Life	Ta=Under Room Temperature As Per Data Sheet Maximum Rating *Test Time=1000HRS(-24HRS,+72HRS)	22	0/1
	High Temperature High Humidity Storage	Ta=85 °C RH=85% Test Time=1000HRS± 2HRS	22	0/1
	High Temperature High Humidity Reverse BIAS	Ta=85 °C RH=85% Test Time=500HRS(-24HRS,+48HRS)	22	0/1
	High Temperature Storage	Ta=105±5 °C *Test Time=1000HRS(-24HRS,+72HRS)	22	0/1
	Low Temperature Storage	Ta=-40±5 °C *Test Time=1000HRS(-24HRS,+72HRS)	22	0/1
	Environmental Test	Temperature Cycling	105 °C ~ 25 °C ~ -40 °C ~ 25 °C 30mins 5mins 30mins 5mins 100Cycles	22
Thermal Shock		105 °C±5 °C ~-40 °C±5 °C 10mins 10mins 100Cycles	22	0/1
Solder Resistance		T.sol=260±5 °C Dwell Time=10±lsecs	22	0/1
Solderability		T.sol=230±5 °C Dwell Time=5±lsecs	22	0/1

The appearance and specifications of the product may be modified for improvement,without prior notice



## M3AW4C06

### 1.Storage

It is recommended that LEDs out of their original packaging are used within one years.

For extended storage out of their original packaging,it is recommended that the LEDs be stored in a sealed container with appropriate desiccant or in desiccators with nitrogen ambient.

### 2. Cleaning

Use alcohol-based cleaning solvent such as isopropyl alcohol to clean the LEDs if necessary.

### 3.Soldering

When soldering leave a minimum of 2mm clearance from the base of the lens to the soldering point.

Dipping the lens into the solder must be avoided.

Do not apply any external stress to the lead frame during soldering while the LED is at high temperature.

Recommended soldering conditions:

Soldering iron		Wave soldering	
Temperature	320°C Max	Pre-heat Pre-heat time	100°C Max 60 sec.Max
Soldering time	3 sec.Max (one time only)	Solder wave Soldering time	260°C Max 5 sec.Max

Note: Excessive soldering temperature and/or time might result in deformation of the LED lens or catastrophic failure of the LED.

### 4.Drive Method

An LED is a current-operated device,In order to ensure intensity uniformity on multiple LEDs connected in parallel in an application,it is recommended that a current limiting resistor be incorporated in the drive circuit,in series with each LED as shown in Circuit A below.

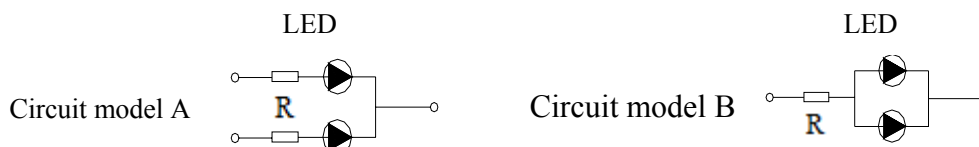

(A)Recommended circuit

(B)The brightness of each LED might appear different due to the differences in the I-V characteristics of those LEDs.